

08.0307.00

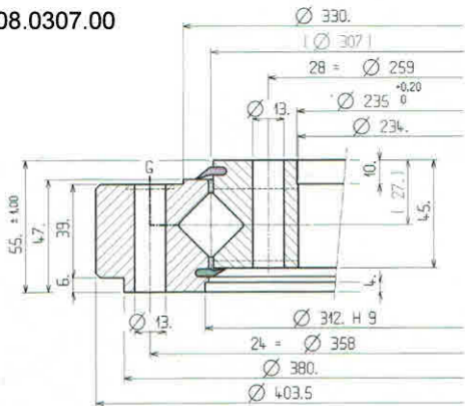

Бec 26 кр