

08.0400.00

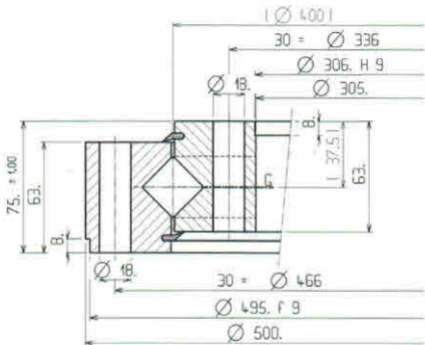

Бec 51 кр